

Commercial Miniature 16mm Size Rotary Encoder

Features

- Robust Construction
- 2-bit Incremental or 4-bit Absolute Encoder
- Optional Momentary Switch
- Available with 16 Detents
- Continuous Rotation
- Bushing Mount
- Solder Lug or PCB Terminals
- RoHS Compliant

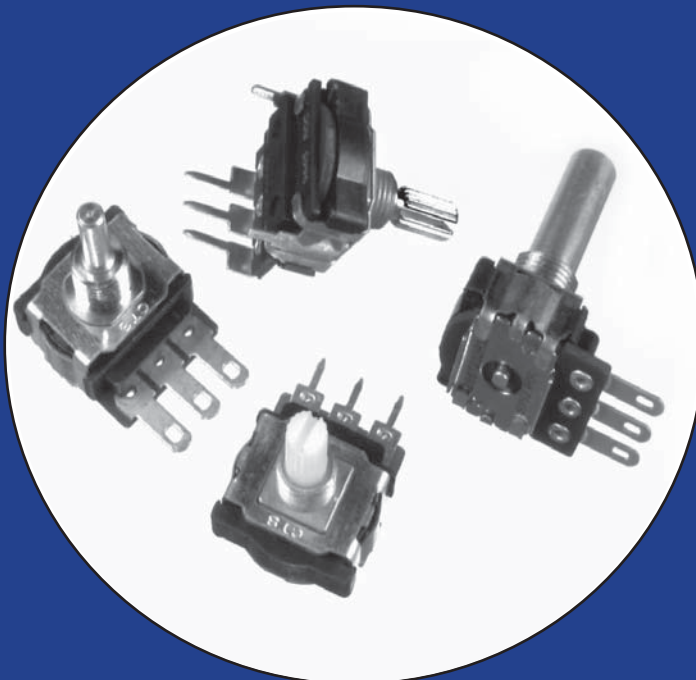

Electrical and Mechanical Specifications

Encoder:

Contact Resistance

500Ω maximum

Voltage Rating

5 VDC @ 0.5mA maximum

Detent Points

16 detents available

Rotational Life

50,000 cycles

Resolution

2-bit: 4, 6, 8, 10 or 12 pulses in 360°

4-bit: 16 combinations in 360°

Insulation Resistance

10MΩ minimum at 50 VDC

Temperature Range

Operating: -25°C to +100°C

Storage: -30°C to +100°C

Rotational Torque

No Detent: 36 - 216 gf.cm

With Detent: 100 - 500 gf.cm

Solder Heat Resistance

260°C for 5 seconds

Push-Pull Strength of Shaft

8 kg minimum for 10 seconds

Special

Consult CTS for customized or features not listed, including other detent points, resolution, torque and mounting style.

288T Typical 2-bit Encoder With Solder Lug Terminals

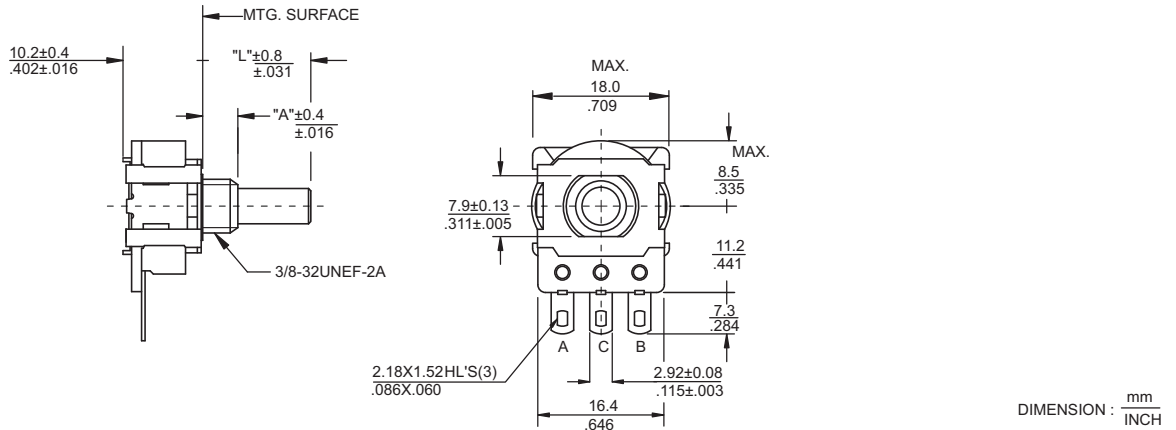

288V Typical 2-bit Perpendicular to P.C. Board

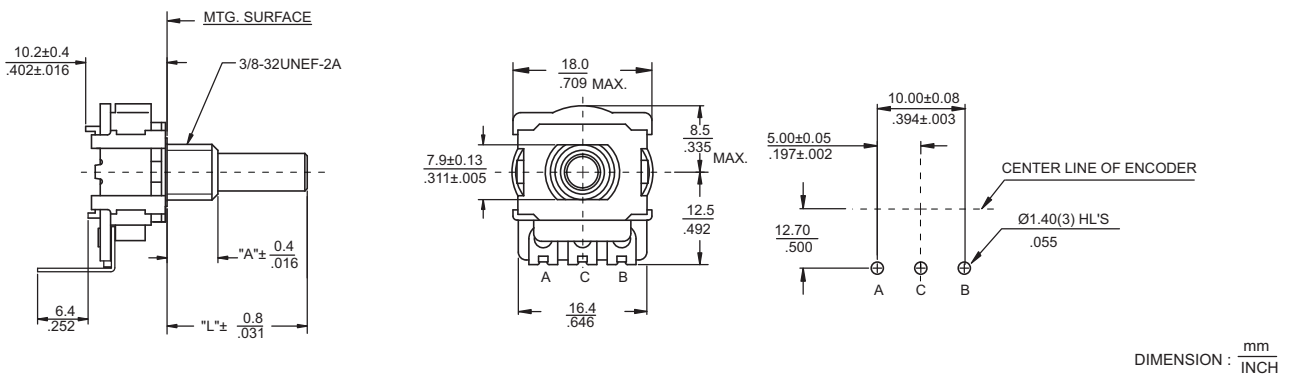

MC-288V Typical 2-bit Encoder With Momentary Switch Perpendicular to P.C. Board

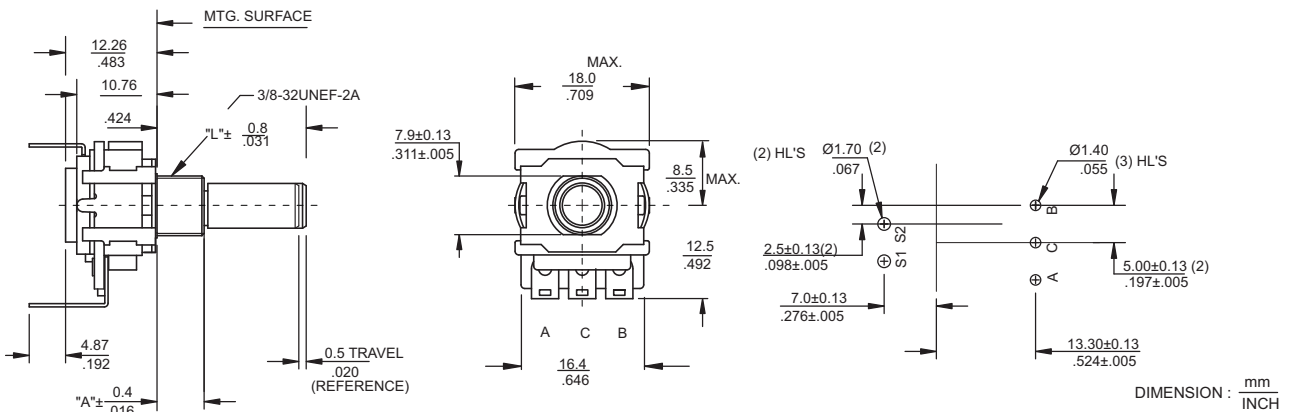

MC-288X Typical 2-bit Encoder With Momentary Switch Parallel to P.C. Board

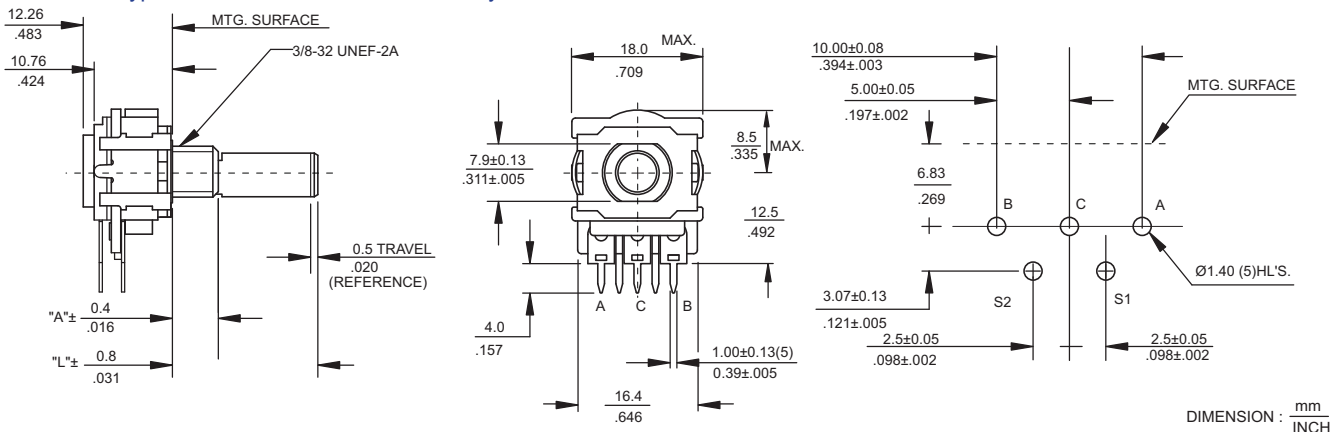

Shaft Trim

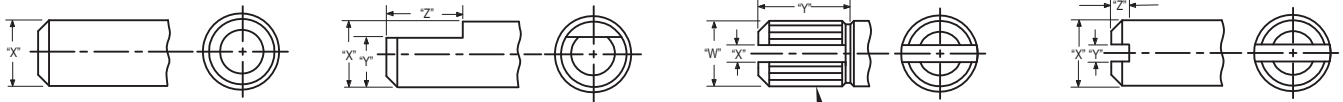

R - ROUND

	X
Imperial Shaft	.250"
Metric Shaft	6.00

F - FLATTED

	X	Y	Z
Imperial Shaft	.250"	.156"	.375"
Metric Shaft	6.00	4.50	7.00

K - KNURLED & SLOTTED

	W	X	Y	Z
Imperial Shaft	.250"	.062"	.344"	24 TEETH
Metric Shaft	6.00	1.57	7.0	18 TEETH

S - SLOTTED

	X	Y	Z
Imperial Shaft	.250"	.046"	.062"
Metric Shaft	6.00	1.17	1.57

DIMENSION: $\frac{\text{inch}}{\text{mm}}$

Ordering Information

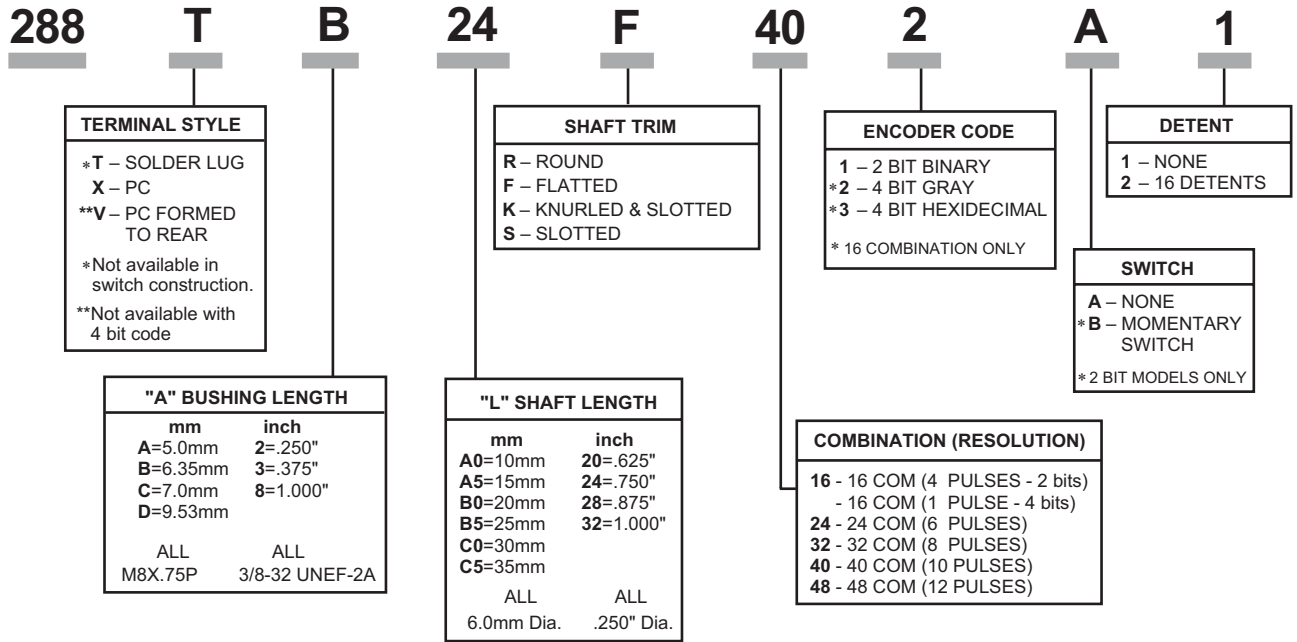

Please consult CTS for customized or features not listed.